

**Tri-Flo Int'l, Inc.**  
P.O. Box 2626, Conroe, Texas 77305  
Bus: (936) 856-8551 Fax: (936) 856-5668

## **SERVICE & OPERATING MANUAL**

### **2 - 4" Mud Cleaner**

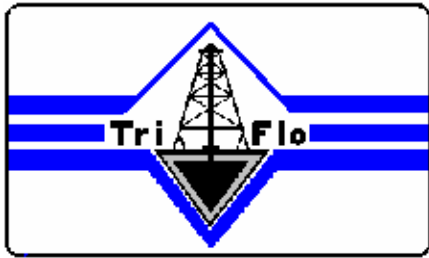



**Tri-Flo Int'l, Inc.**  
 P.O. Box 2626, Conroe, Texas 77305  
 Bus: (936) 856-8551 Fax: (936) 856-5668

## TABLE OF CONTENTS

	<b>Page</b>
Introduction	3
Operation	4
Adjustments	5
Location	5
Maintenance	6
Troubleshooting	6
Installation	7
Power Requirements	7
Screen Installation	8
Lubrication	8
Adjustments	9
Maintenance	10
Inspection	10
Disassembly of the Vibrator	11
Reassembly of the Vibrator	12
Changing Deck Springs	13
Electric Motors	13
Troubleshooting	14
Vibrator Assembly	14
Short Screen Life	15
Safety	15
Tightening Torques for High strength Bolts	16
Recommended Lubricants	16
Forces	16
Screen Sizes	17
Recommended Spare Parts	18
Vibrator Assembly Breakdown	19
Vibrator Assembly Drawing	20
Parts List	21
General Hook-Up for Mud Cleaner	22
Spray Discharge for Hydro cyclone	23
Location Diagram	24
Mechanical Solids Control for Weighted Drilling Fluid	25
Wiring Diagram	26
Tension Plate and Screen Assembly	27
Table of Common Oilfield Shaker Screens	28
Vibrator Assembly	29

## INTRODUCTION

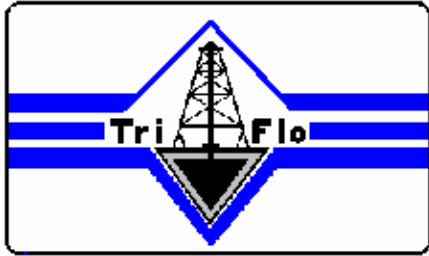

## **Tri-Flo Int'l, Inc.**

**P.O. Box 2626, Conroe, Texas 77305  
Bus: (936) 856-8551 Fax: (936) 856-5668**

The TRI-FLO 2 Cone Fluid Separator (Mud Cleaner) is a combination of a TRI-FLO Sand/Silt Separator and a TRI-FLO 113 Shale Shaker.

The TRI-FLO Fluid Separator is designed to remove the sand and silt sized particles before they have a chance to break down even smaller. The TRI-FLO Fluid Separator operates efficiently on weighted mud as well as unweighted mud systems.

The TRI-FLO Fluid Separator is designed to save barite and remove low gravity solids larger than barite from weighted mud system. The Sand/Silt Separator Hydro-cyclones will separate the low solid liquid slurry from the barite and larger than medium silt range particles. The barite and larger silt size particles will be directed on the screen surface to save barite and drilling fluid while the large silt size particles will go off the end of the screen.

On the unweighted mud systems the TRI-FLO Fluid Separator will reduce the costs by reduced jetting, less chemical replacement and less replacement of water and/or oil. With the use of 400 mesh screens it is possible to remove solids to approximately 25-micron silt size particle.

The TRI-FLO Fluid Separator has several design characteristics that justify its ability to remove sand and silt sized solids from the drilling fluid. The feed manifold is designed with an angled pitch to insure balanced feed pressure into the hydro cyclones. System balance is achieved by opening or closing individual control valves on each hydro cyclone, by lowering or raising the siphon tubes on each overflow tube, and/or increasing or decreasing the apex valve size. Any of these adjustments can alter the GPM rate and handle most volume requirements. These adjustments can make particle interference, mud viscosity, and rejection volume less critical and enable the system to work more efficiently. The TRI-FLO Fluid Separator can remove solids that are often found to be the cause of drill collar sticking and wear on mud pump expendables.

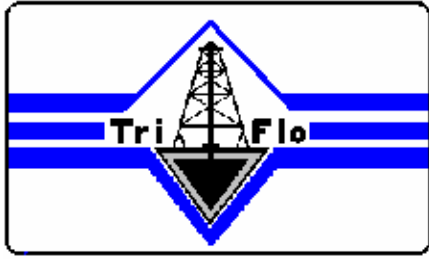

## Tri-Flo Int'l, Inc.

P.O. Box 2626, Conroe, Texas 77305  
Bus: (936) 856-8551 Fax: (936) 856-5668

### OPERATION

The feed slurry of solids and liquid is fed through the inlet at a high velocity obtained by steady pressure of twenty-five **(25) psi**. The high velocity transmitted to the feed section creates a spinning velocity and resulting centrifugal forces. The vortex finder causes the stream to spiral downward towards the underflow solids discharge. Centrifugal force and inertia causes solids to settle outward toward the hydro cyclone wall, in a downward spiraling stream.

The solids separate according to size and weight of the particles. In the density range of solid particles in drilling fluids, size is of far more influence than the variations in density so that basically the biggest particles settle first and fastest.

The cone section narrows, inner layers of the downward spinning liquid turn back toward the overflow because of the increasing centrifugal forces near the center.

In the TRI-FLO's hydro cyclone, as the last of the liquid moves to the center and back upward toward the overflow, the downward spiraling solids continue out the apex, not being able to turn back because of their greater inertia and high downward velocity. Therefore, the actual solids removal at the underflow is by inertia, not by settling. The underflow rate and density varies with the volume and size of solids being separated to the underflow.

The TRI-FLO 16-4" Fluid separator can handle up to 1040 GPM of drilling fluid.

The TRI-FLO 8-4" Fluid Separator can handle up to 520 GPM of drilling fluid.

The TRI-FLO 6-4" Fluid Separator can handle up to 390 GPM of drilling fluid.

The TRI-FLO 4-4" Fluid Separator can handle up to 260 GPM of drilling fluid.

The TRI-FLO 2-4" Fluid Separator can handle up to 130 GPM of drilling fluid.

The underflow from the fluids, even under extreme conditions, will be approximately 40 GPM and ordinarily under 30 GPM. This makes it possible to use fine mesh screen (150-200 mesh) to clean all of the mud returning from the bore hole. 200 mesh screens have openings of 74 microns and the 150 mesh screens have openings of 104 microns. Theoretically, particles smaller than these openings should remain with the mud and larger particles and would be carried off the end of the shaker.

### ADJUSTMENTS

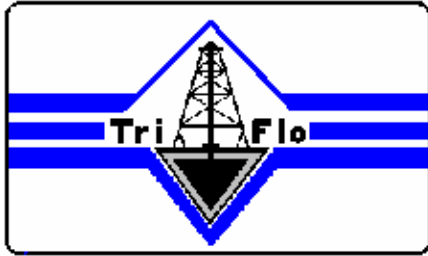

## Tri-Flo Int'l, Inc.

P.O. Box 2626, Conroe, Texas 77305  
Bus: (936) 856-8551 Fax: (936) 856-5668

The TRI-FLO Fluid Separator is operated at **25 psi** of pressure. A six (6) inch butterfly valve should be placed in the discharge line between the centrifugal pump and the manifold inlet. This valve would be used for adjusting the manifold pressure to 25 psi.

Each hydro cyclone has a two (2) inch butterfly valve located before the feed inlet. This valve permits the operator to turn off each hydro cyclone individually for system balance and removal of the hydro cyclone, without shutting down the entire system. TRI-FLO does not recommend this valve to be used as a flow adjustment and should be either fully open or fully closed.

The siphon tubes, located on the top of the overflow tubes are an adjustment of the underflow. When the siphon tube is completely down, the air entering the apex bushing is increased and less drilling fluid is permitted to spray out the apex of the hydro cyclone.

When a more wet underflow with more fine solids is desired, the siphon tube should be raised. This adjustment will reduce the amount of air permitted through the apex and cause a wetter underflow to travel to the shaker screen. The distance the siphon tube should be raised will vary with the drilling conditions and no hard fast rule will apply.

The apex nut and apex bushing are designed for easy removal when plugging becomes a problem and are adjustable to permit the required amount of spray discharge desired. When a smaller opening is necessary tighten the apex nut to the desired setting. The tighter the adjustment the less air permitted to enter the bottom of the hydro cyclone. At times when plugging is a problem, the apex nut and the apex bushing can be removed. This may be necessary when drilling a surface hole or when large amounts of sand are present.

### **CAUTION:**

Over tightening of the apex nut and apex bushing will cause the hydro cyclone to become plugged. When the hydro cyclone becomes plugged severe erosion will occur in the feed section of the hydro cyclone and may damage the interior of the hydro cyclone. The damage will first be noticed in the zone of maximum wear on Figure 1 and may make the hydro cyclone virtually useless.

The TRI-FLO hydro cyclone consists of a feed section, cone section, apex nut, apex bushing and a clamp.

### **LOCATION**

The TRI-FLO Fluid Separator should be mounted level on the mud tank next to the Shale Shaker. The centrifugal pump supplying the TRI-FLO Fluid Separator should have the suction in the compartment of the Shale Shaker discharge if a degasser is not used. If a degasser is used, the TRI-FLO Fluid Separator suction line should be in the compartment of the degasser's discharge. The TRI-FLO Separator should have a six (6) inch supply line from a separate centrifugal pump to the manifold inlet. See page 22.

### **MAINTENANCE**

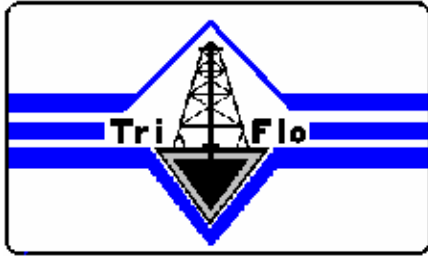

## **Tri-Flo Int'l, Inc.**

**P.O. Box 2626, Conroe, Texas 77305  
Bus: (936) 856-8551 Fax: (936) 856-5668**

The TRI-FLO Fluid Separator is a high performance piece of mud equipment and requires a regular maintenance program.

Hydro cyclone wear and performance is highly dependent of the feed pressure and the conditions of the hydro cyclones. The pressure should never exceed 25 psi, as more than 25 psi will cause excessive wear on the hydro cyclones.

Damaged or worn, hydro cyclones will not separate the fine drill solids from the drilling fluid and need to be checked periodically for wear.

### **TROUBLESHOOTING**

**PROBLEM:** Pressure at the manifold too low:

**CAUSE:** Is the pump impeller large enough to deliver 25 psi?  
Is the pump speed correct?  
Is the supply line from the pump to the manifold six (6) in diameter?  
Is the pump supplying any other piece of equipment?  
Is the supply line to the manifold plugged?  
Is the centrifugal pump suction plugged?

**PROBLEM:** No underflow or too little underflow:

**CAUSE:** Is the feed pressure at 25 psi?  
Is the apex bushing plugged?  
Is the apex bushing closed too tightly?  
Are there fine-drilled solids in the mud?  
Is the valve to the hydro cyclone open?  
Is the pump running?

**PROBLEM:** Too much underflow:

**CAUSE:** Is the hydro cyclone feed suction or cone section damaged?  
Is the apex bushing in the hydro cyclone?  
Is the pressure too high?

### **INSTALLATION**

### **POWER REQUIREMENTS**

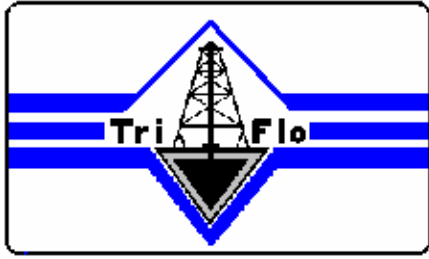

## **Tri-Flo Int'l, Inc.**

**P.O. Box 2626, Conroe, Texas 77305  
Bus: (936) 856-8551 Fax: (936) 856-5668**

Connect the power cable from the motor starter switch to the rig power supply. Connect the green insulated wire to ground.

The TRI-FLO 113 Shale Shaker is wired at the factory for 460 V.A.C. 3 phase, 60 Hz or 380 V.A.C. 3 Phase, 50 Hz. depending on the application.

If 230 V.A.C. 3 phase 60 Hz. is needed it is necessary to:

1. Rewire the motor. (See page 26)
2. Change the heater strips.
3. Change Sheave size.

Turn the starter switch on and check the motor rotation. The top of the belt should travel in the same direction as the flow of the mud. This is from the "possum belly flume" of the shaker to the "solids discharge end."

If the rotation is incorrect, change any two of the red, black or white wires at the motor junction box at the rig power supply. The green wire should always be ground and would not effect the rotation of the motor.

## **SCREENS**

The procedure to installing or changing screens on the 113 Shale Shaker is as follows:

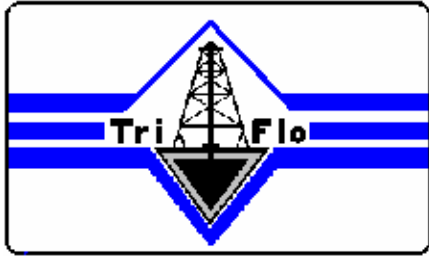

## **Tri-Flo Int'l, Inc.**

P.O. Box 2626, Conroe, Texas 77305  
Bus: (936) 856-8551 Fax: (936) 856-5668

1. Remove the tension lock nuts, washers, tension springs, tension bolts and tension rail plates from the screen box. (See tension plate detail).
2. Install or check the decking rubber for wear and make sure the rubber is sitting on the screen support bars properly.
3. Install the screen in position, leaving equal space on each side. When installing the screen be careful not to bend or crease the screens.
4. Put the tension plates in position with the bolts extending through their respective holes in the side of the plates of the screen box. The tension rails should only touch the hood strips and not the screen.
5. Install the springs, washers and lock nuts. Tighten the tension lock nuts to expose 1/8" of the threads, starting at the center and working toward each end.
6. Check the screen for creases and ripples. If any appear, the hook strips are not even. Work out the wrinkles by hand by adjusting the position of the hook strips and by smoothing the screen cloth by hand.
7. Tighten the center tension lock nuts to expose 5/8" of threads, then tighten the other nuts the same amount, working from one side and then the other.
8. Tighten the nuts enough to fully compress the tension springs. Rap the tension plate and the tension bolt heads lightly with a hammer to insure that the bottom of the tension plate is parallel to the support bar. After fully compressing the springs they will maintain tension on the screens. It is recommended that after three (3) hours of running the tension nuts should be retightened.
9. Wet the screens with water (or diesel when using oil mud) before diverting mudflow over the screen.

### **LUBRICATION**

TRI-FLO recommends that the grease fittings located on top of each cartridge, or the lubricator hose assembly on the side of the later models, be greased every twelve (12) hours. Normal services requires approximately one half (1/2) ounce of grease in each bearing each twelve (12) hours. (See Page 16 for recommended bearing lubricants)

### **ADJUSTMENTS**

The intensity of vibrations may be varied to suit conditions by changing the position of the adjustable counterweights. Position 1 gives maximum, and each successive notch or setting reduces the motion. Position 6 gives the minimum intensity of vibrations. It is important that both

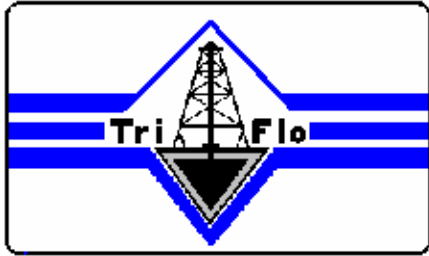

## **Tri-Flo Int'l, Inc.**

**P.O. Box 2626, Conroe, Texas 77305  
Bus: (936) 856-8551 Fax: (936) 856-5668**

counterweights have the same setting. This is easily checked by the alignment on the notches in the counterweights.

Other factors such as screen incline and vibrator speed may be adjusted under some circumstances, under the guidance and direction of TRI-FLO INTERNATIONAL, INC.

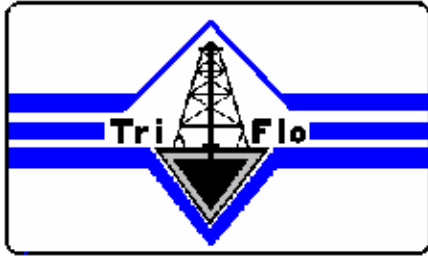

## Tri-Flo Int'l, Inc.

P.O. Box 2626, Conroe, Texas 77305  
Bus: (936) 856-8551 Fax: (936) 856-5668

### MAINTENANCE

#### INSPECTION

A regular schedule of complete dismantling, inspection, and relubrication intervals assures maximum screen life and minimum downtime. The customer should keep a complete record of all such preventive maintenance plus a record of any repairs. Since the TRI-FLO High Speed Shale Shaker is a vibratory machine, it is important to correct all minor troubles before serious damage develops. Replace faulty support springs and any missing bolts at once. Cracks forming in the structure (usually at or near the joints) and unusual noises and motion are signs of developing failure. Drill 1/4" holes through the ends of such cracks and consult TRI-FLO at once in the event of such failures. **Warning: if welding is done do not ground welder through vibrating screen.**

After 1500 to 2000 hours of operation, dismantle the vibrator mechanism and clean all parts. Flush bearings with a 200 light transformer, or automotive flushing oil. Check screen tension periodically. On reassemble, pack the bearing with grease and also fill the adjacent cavity in the housing and retainer with grease to the bottom of the shaft.

#### DISASSEMBLY OF THE VIBRATOR

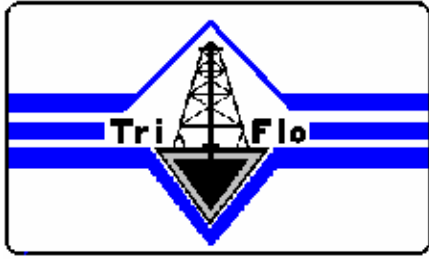

## Tri-Flo Int'l, Inc.

P.O. Box 2626, Conroe, Texas 77305  
Bus: (936) 856-8551 Fax: (936) 856-5668

**WARNING:** DISCONNECT POWER TO THE ELECTRIC MOTOR AND LOCK THE DISCONNECT SWITCH IN THE OPEN POSITION.

1. Remove motor and drive pulley guard.
2. Remove the counterweight guard from both ends of the vibrator shaft.
3. Loosen the four motor support bolts located under the motor, loosen the V-belts and remove them.
4. Remove the V-belt sheave (Item W, Page 19) by first loosening its taper lock hub.
5. Remove the counterweights (Item R page 19) by removing the clamp screws and reusing the screw to open the slots in the counterweights, by tightening the screws into the tapped holes.
6. Remove the index collars (Item G/H page 19) and the retainers (Item C) with the spiro lox rings (Item D) in their grooves. Remove cartridge cap screws (Item P).
7. Remove retaining ring (Item K) from the drive side only. By striking on one end of the shaft (Item B) with a lead hammer or a hammer and a block of hardwood, it is possible to start to drive out the cartridge (Item T) on the other side.
8. Then it should be easy to pry either or both cartridges loose from their bores in the housing ends. If difficulty is experienced, a cartridge can be bumped from the inside by striking the shaft again at the other end. When one cartridge is removed the shaft can be slipped from the housing.
9. The bearing remaining in the other cartridge should be removed by using 3" long 3/8" NC cap screw and pushing the bearing out. Before inserting the cap screws, the setscrews must be removed.

## REASSEMBLY OF THE VIBRATOR

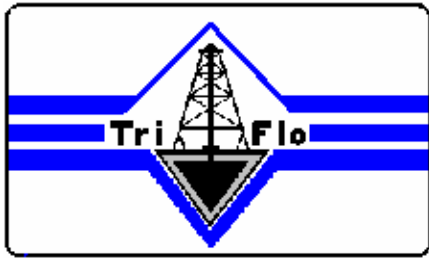

## Tri-Flo Int'l, Inc.

P.O. Box 2626, Conroe, Texas 77305  
Bus: (936) 856-8551 Fax: (936) 856-5668

1. Be sure the housing, cartridges, bearings, shafts, etc. are clean. Flush the bearing with (200° F) light transformer, spindle, or automotive flushing oil; **DO NOT USE KEROSENE OR GASOLINE.**
2. Be sure that the shaft and bearing turn freely. Grease the bearing liberally with a recommended grease. See page 16 for recommended bearing grease.
3. Make a sub-assembly of the bearings, cartridges, spiro lox rings, and the setscrew. The latter must be replaced in the cartridges as in the original assembly if they have been removed to use longer cap screws for bearing removal.
4. Place the shaft into the housing. Slide the cartridge-bearing sub-assembly onto the Drive side of the shaft, rotating the sub-assembly to aid in expansion of the Spiro lox rings. Install the snap-ring onto the shaft. Now slip the cartridge-bearing sub-assembly that is secured on the shaft into the housing to secure the shaft axially.
5. Slip the other cartridge-bearing sub-assembly over the shaft on the side opposite the drive end. Push and tap it into position in the housing end, lifting on the shaft end to center all components properly. Secure cartridges with cap screws (Item U) and lock washers (Item V). See Page 16 for torques of the cap screws.
6. Slip spiro lox rings (Item D, page 19) into the retainer grooves. Pack the retainers (Item C) with grease to the bottom of the shaft. Slip over the shaft ends, push into position, and fasten with cap screws (Item P). Torque all bolts and cap screws on the vibrator assembly to specifications listed on page 16 entitled tightening torques for high strength bolting.
7. Put indexing collars (Item G / H) on shafts. The notched edge of these collars should face the shaft ends. Looking down on these collars, the numbers on the indexing bands will read counter clockwise on one side and clockwise on the other side. Secure the setscrew collars over the key. Index collars are marked (Dr.) for Drive and (ODr.) for Off-Drive.
8. Mount the counterweight (Item R) on the shafts using the clamp screw in the tapped hole to open the slot to facilitate mounting. Make certain that the projecting lugs of each counterweight engage with the corresponding numbered notches in the indexing collars (Item G / H) to produce equal unbalancing or vibrating effects at each end of the shaft.
9. Remove the clamp screw from the tapped hole and insert into the through hole in the counterweight. Secure the counterweight by tightening the clamp screws.
10. Install the V-belt sheave (Item W) and it's Quick-Disconnect bushing onto the shaft and secure by tightening the bolts in the Quick-Disconnect bushing.

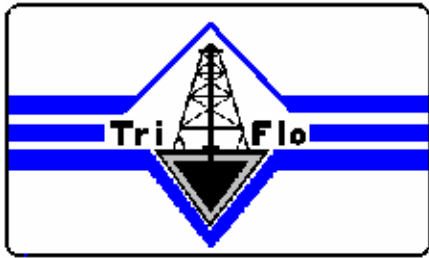

## **Tri-Flo Int'l, Inc.**

**P.O. Box 2626, Conroe, Texas 77305  
Bus: (936) 856-8551 Fax: (936) 856-5668**

11. Install the V-belts and tighten the motor support bolts after the V-belts are adjusted. Tighten only enough to prevent slippage when starting and to prevent belt whip.
12. Install the counterweight guards and the motor pulley guard.
13. Check the bolts for fastening the vibrator housing to the screen box. These bolts should be tightened to 210 ft. lbs. See page 16 for bolt torque's.

### **CHANGING THE SPRING COILS ON VIBRATING DECK**

The spring coils on the vibrating deck should be checked every 6 months. When the spring shrinks or collapses to less than 4 inches they should be replaced. A new spring measures 4 1/2 inches. This is done by lifting the shaker box, removing the old springs, and installing the new ones.

### **ELECTRIC MOTOR**

1. Check for loose bearings.
2. Check the mounting bolts.
3. Check the belt tension.
4. Inspect the power cable for wear between the switch and the motor.

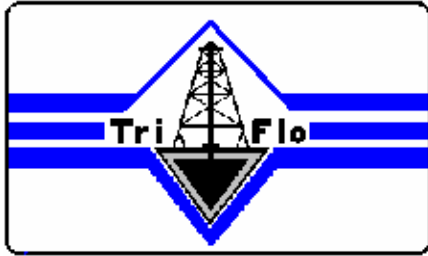

## **Tri-Flo Int'l, Inc.**

**P.O. Box 2626, Conroe, Texas 77305  
Bus: (936) 856-8551 Fax: (936) 856-5668**

### **TROUBLESHOOTING**

#### **VIBRATOR MECHANISM**

##### OVERHEATING OF THE BEARING

1. CAUSE: Too little lubricant  
SOLUTION: Check seals for leakage and add lubricant.
2. CAUSE: Too much lubricant-  
SOLUTION: Remove lubricant until proper amount is indicated.
3. CAUSE: High ambient temperature caused by handling hot material or by surrounding condition.  
SOLUTION: Ventilate area or use high temperature lubricant.

##### LUBRICANT LEAKAGE

1. CAUSE: High temperature causes grease to become fluid and leak through the seals.  
SOLUTION: Use high temperature grease.

##### GRITTY BEARING

1. CAUSE: Entrance of grit while servicing or through the seals during operation.  
SOLUTION: Flush bearing and cartridge and relubricate.

##### NOISY BEARING

1. CAUSE: Bearing Failure caused by mentioned reasons.  
SOLUTION: Replaced bearings: take necessary precautionary steps to avoid reoccurring failure.
2. CAUSE: Normal fatigue failure associated with the vibrator service identified by spalling or roller and inner race at the high load zone.  
SOLUTION: Replace bearings; see assembly instructions.

##### ERRATIC VIBRATION OR PERFORMANCE

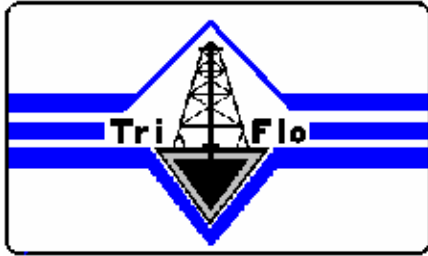

## Tri-Flo Int'l, Inc.

P.O. Box 2626, Conroe, Texas 77305  
Bus: (936) 856-8551 Fax: (936) 856-5668

1. CAUSE: Slipping of the V-Belts.  
SOLUTION: Replaced worn belts or tighten loose belts.
2. CAUSE: Throwing of V-Belts.  
SOLUTION: Check belt alignment; check counterweights to insure they are on the same setting.
3. CAUSE: Unit is not level.  
SOLUTION: Relevel the shaker with shims.

### SHORT SCREEN LIFE

1. Careless handling and installation.
2. Failure to clean all support surfaces prior to screen installation.
3. Improper tension during installation.
4. Tension plates not seated properly
5. Cuttings build up under the edge of the screen.
6. Worn deck rubber.

### SAFETY

No person should stand, hold or lean against the vibrating frames. Vibrations transmitted to the human body can be harmful. These screens are not therapeutic devices.

Because of the motion of the vibrating screen it is impossible to service the shaker while in motion. Never lay tools or spare parts on the screens. **Only trained personnel should operate or repair this shaker.**

### TIGHTENING TORQUES FOR HIGH-STRENGTH BOLTS

Cap screws or bolt

Torque Foot Pounds

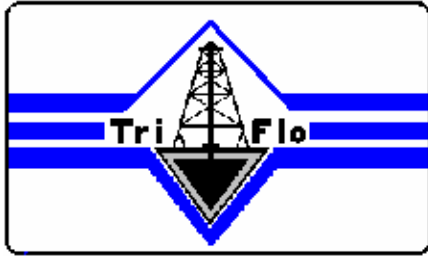

**Tri-Flo Int'l, Inc.**  
 P.O. Box 2626, Conroe, Texas 77305  
 Bus: (936) 856-8551 Fax: (936) 856-5668

diameter, inches  
 3/8"  
 1/2"  
 5/8"

<u>Bolts</u>	<u>Cap screws</u>
41	47
105	120
210	210

**RECOMMENDED LUBRICANTS**

---

Shell Oil Co.	Alvania No. E P-2
Texaco Inc.	Multifax No. E P-2
Gulf Oil Co.	Crown No. 2
Chevron Oil Co.	Duralith No. E P-2
Mobil Oil Corp.	Mobilux E P-0,1,2
Universal	Mollux No. 3400
Citgo	Mystik SX-6 Extreme Temp. -65 to 350 degrees
Citgo	Mystik JT-6 High Temp.

**FORCES**

Forces generated by TRI-FLO's 113-vibration screen at various counterweight settings.

---

<b>Settings</b>	<b>Unbalance (inch-lbs.)</b>	<b>Stroke (inches)</b>	<b>Forces (g's)</b>
1	31.0	.101	4.4
2	29.8	.097	4.2
3	26.8	.087	3.8
4	21.9	.071	3.1
5	15.4	.050	2.2
6	8.0	.026	1.1

**SCREEN SIZES / PART NUMBERS**

MESH

TRI-FLO PART NO

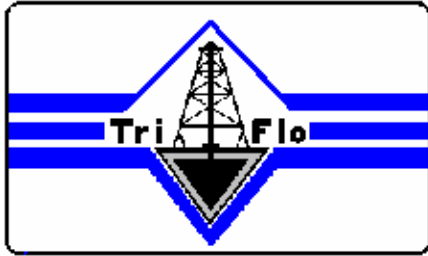

## Tri-Flo Int'l, Inc.

P.O. Box 2626, Conroe, Texas 77305  
Bus: (936) 856-8551 Fax: (936) 856-5668

10 Mesh Screen	05-00-481
20 Mesh Screen	05-00-482
30 Mesh Screen	05-00-463
40 Mesh Screen	05-00-464
50 Mesh Screen	05-00-475
60 Mesh Screen	05-00-479
80 Mesh Screen	05-00-478
100 Mesh Screen	05-00-462
120 Mesh Screen	05-00-469
150 Mesh Screen	05-00-470
180 Mesh Screen	05-00-471
200 Mesh Screen	05-00-472
250 Mesh Screen	05-00-465
325 Mesh Screen	05-00-466
400 Mesh Screen	05-00-467

### RECOMMENDED SPARE PARTS

Always order spare parts from **TRI-FLO INTERNATIONAL, INC.** This is particularly true of bearings, which may not be available from the local bearing sources because of the special internal clearance requirements.

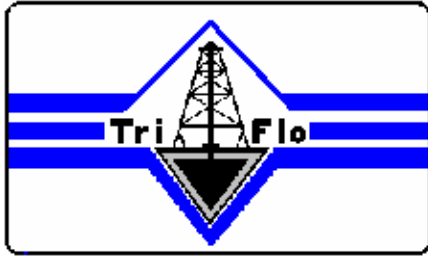

## Tri-Flo Int'l, Inc.

P.O. Box 2626, Conroe, Texas 77305  
 Bus: (936) 856-8551 Fax: (936) 856-5668

It is advisable to stock the following spare parts so that breakdowns can be repaired promptly and costly delays eliminated.

### 113 Shale Shaker spare parts list.

---

Name of Part	Qty.	Tri-Flo Part No.
Bearing	2	05-00-043
Bearing Cartridge	2	05-00-345
V-Belts	2 sets	05-00-068
Tension Bolt Assemblies	12	03-00-006
Spiro lox Ring-Retainer	4	03-00-008
Spiro lox Ring-Cartridge	4	03-00-009
Spring Coil (Vibrating Deck)	4	03-00-005
Retaining Ring	1	05-00-322

Recommended Spare Part for 2 Cone Fluid Separator or Sand/Silt Separator.

Name of Part	Qty.	Tri-Flo Part No.
Hydro cyclone Complete 4"	2	03-00-044
Victaulic Coupling 2"	6	00-00-047
Victaulic Gasket 2"	6	00-01-008
Siphon Rod Seals	2	01-00-011
Pressure Gauge	1	02-00-020
Apex Bushing	2	03-00-048
Apex Nut	2	03-00-047

---

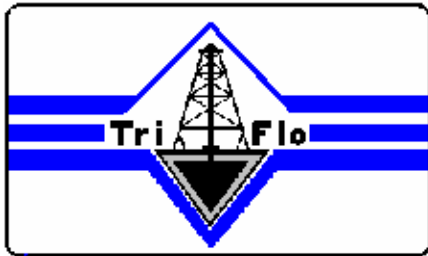

## Tri-Flo Int'l, Inc.

P.O. Box 2626, Conroe, Texas 77305  
 Bus: (936) 856-8551 Fax: (936) 856-5668

### TFI-113 SHAFT ASSEMBLY PARTS LIST

No.	QTY	PIN	DESCRIPTION
A	1	05-00-351	Vibrator Housing
B	1	03-00-050	Vibrator Shaft
C	1	03-00-027	Retainer
D	4	03-00-008	Spiro lox Ring – Retainer *4
E	4	03-00-009	Prolix Ring – Cartridge *4
F	2	05-00-388	Set Screw for Collar
G	1	05-00-349	Collar (Drive End)
H	1	05-00-377	Collar (Opp End Drive)
J	2	05-00-043	Bearing *2
K	1	05-00-322	Retaining Ring - Truarc *1
L	6	05-00-046	Set Screw
M	2	05-00-186	Grease Fitting (Zert)
P	8	04-00-090	Cap screw - 3/8"
Q	8	04-00-169	Lock washer - 3/8"
R	2	05-00-129	Counterweight
S	2	04-00-109	Counterweight Bolt 5/8" x 4"
T	2	05-00-345	Cartridge
U	8	04-00-130	Cap screw 1/2" Grade 8
V	8	04-00-162	Lock washer 1/2"
W	1	05-00-344	V Belt Pulley
X	1	05-00-083	V Belt Pulley Bushing
Y	1	05-00-239	Key stock 1/2" x 1/2" x 1 1/4"
Z	1	05-00-240	Key stock 1/2" x 1/2" x 1"

**\* INDICATES QUANTITY OF RECOMMENDED SPARES**

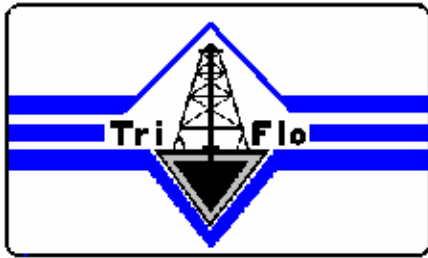

**Tri-Flo Int'l, Inc.**  
P.O. Box 2626, Conroe, Texas 77305  
Bus: (936) 856-8551 Fax: (936) 856-5668

**TFI-113 SHAFT ASSEMBLY**

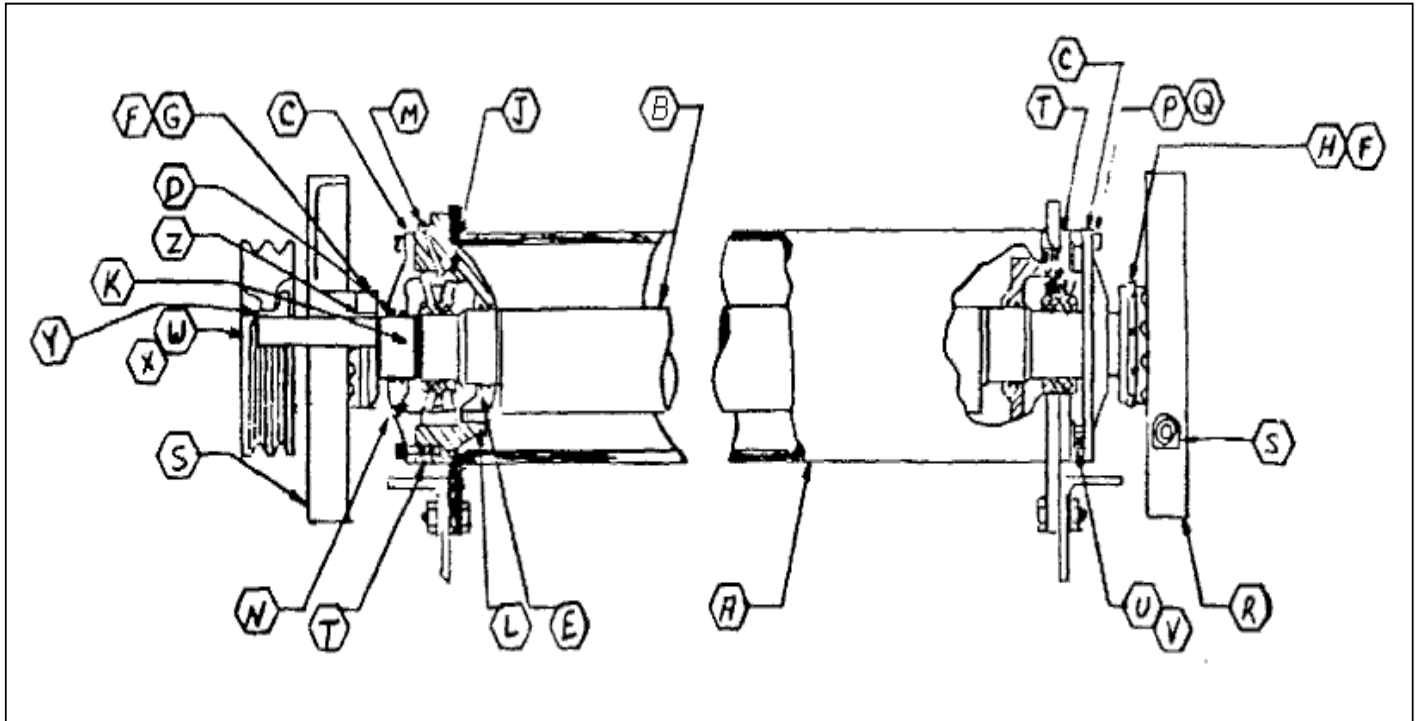

**TRI-FLO PARTS PRICE LIST  
TFI 113 SHALE SHAKER**

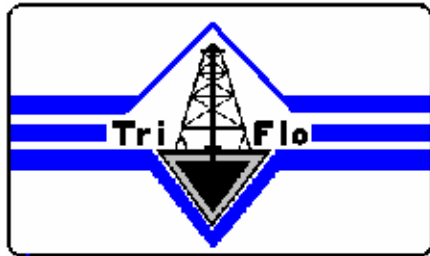

## Tri-Flo Int'l, Inc.

P.O. Box 2626, Conroe, Texas 77305  
 Bus: (936) 856-8551 Fax: (936) 856-5668

Part No.	Description
01-00-055	Heater Strip H-23
01-00-081	Starter - Size 0 Nema 12
01-00-099	Starter - Size 0 Nema
01-00-082	Starter Block
01-00-149	Motor - 2HP TEFC 1800 RPM
01-00-145	Motor - 2HP XP 1800 RPM
03-00-004	Decking Rubber
03-00-005	Deck Spring
03-00-006	Tension Bolt Assembly
04-00-014	Tie Down Assembly
03-00-007	Tension Rail
03-00-008	Retainer Ring - Spiro lox
03-00-009	Cartridge Ring - Spiro lox
03-00-027	Bearing Retainer
03-00-038	Vibrating Shaft
04-00-090	Retainer Cap Screw
04-00-107	Tension Bolt
04-00-130	Cartridge Cap Screw
04-00-150	Tension Bolt Nut
04-00-162	Cartridge Lock Washer
04-00-169	Retainer Lock Washer
05-00-043	Bearing
05-00-046	Set Screw - Bearing Cartridge
05-00-065	05-00-069 (50 hz)
	Drive Belt B-63 / B-64 (50 hz)
05-00-084	Bushing (Vibrator) - 1-7/8
05-00-082	Bushing (Motor) - 1-1/8
05-00-129	Counterweight
05-00-239	Key stock Pulley
05-00-240	Key stock Collar
05-00-322	Shaft Retaining Ring
05-00-341	05-00-352 (50 hz)
	Sheave 1B 5.6SDS / 1B 6.8SDS
05-00-345	Bearing Cartridge
05-00-349	Index Collar - Drive End
05-00-350	Tension Springs
04-00-177	Tension Bolt Washers
05-00-377	Index Collar - Non Drive End
05-00-388	Set Screw - Index Collar
03-01-019	Belt Guard - Complete
05-02-005	Counterweight Guard

Drawing - General Hook-up for Mud Cleaner/Sand Silt Separator

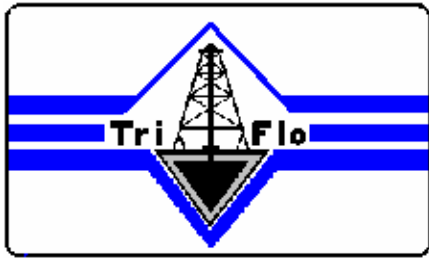

# Tri-Flo Int'l, Inc.

P.O. Box 2626, Conroe, Texas 77305  
 Bus: (936) 856-8551 Fax: (936) 856-5668

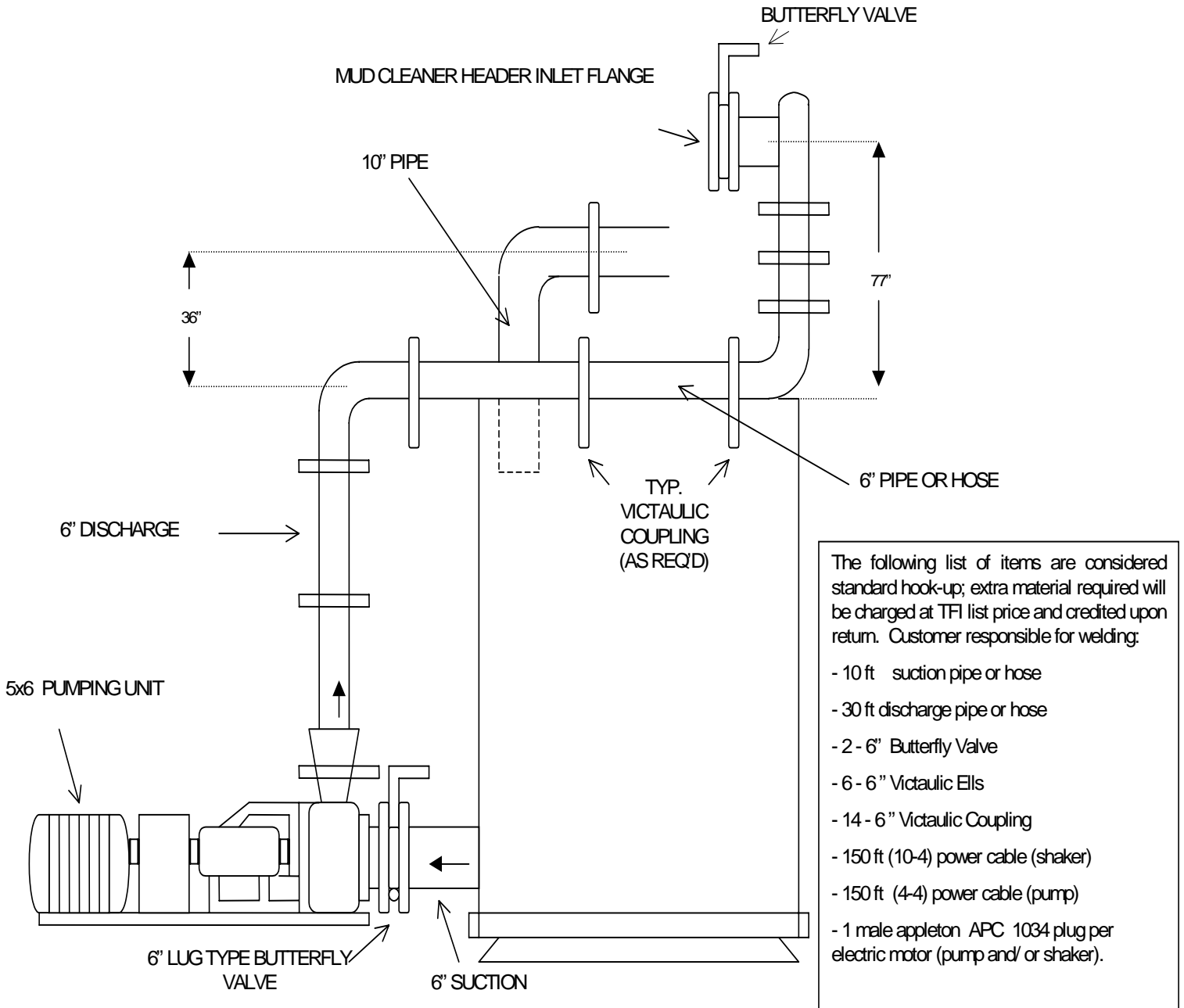

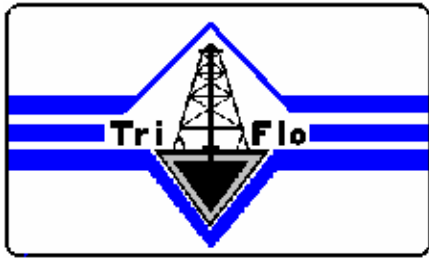

**Tri-Flo Int'l, Inc.**  
 P.O. Box 2626, Conroe, Texas 77305  
 Bus: (936) 856-8551 Fax: (936) 856-5668

**Drawing: Spray Discharge of Hydro cyclone**

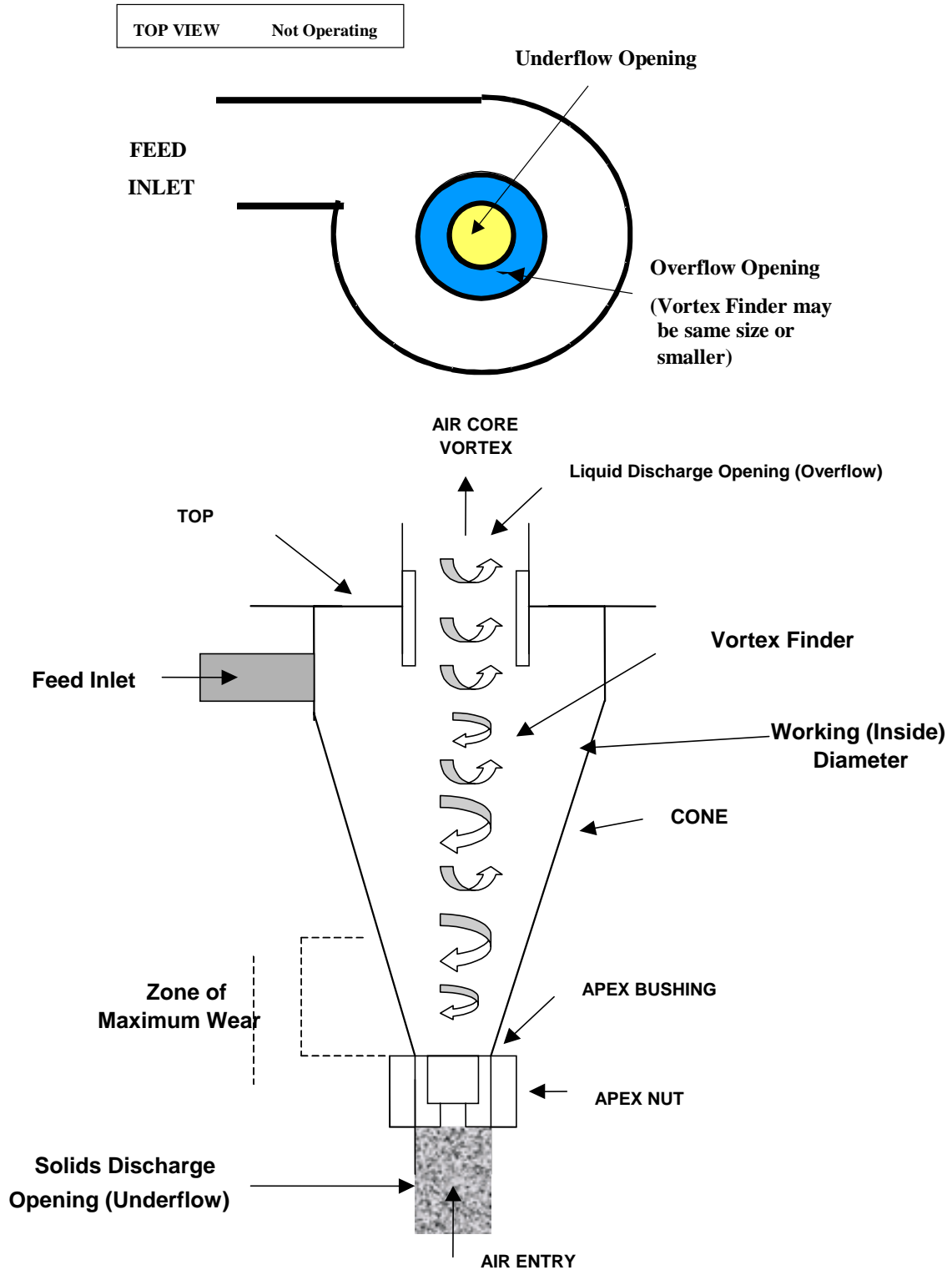

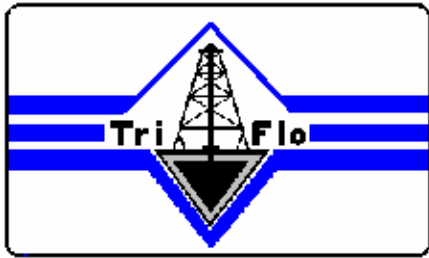

**Tri-Flo Int'l, Inc.**  
 P.O. Box 2626, Conroe, Texas 77305  
 Bus: (936) 856-8551 Fax: (936) 856-5668

**Drawing: Location Diagram**

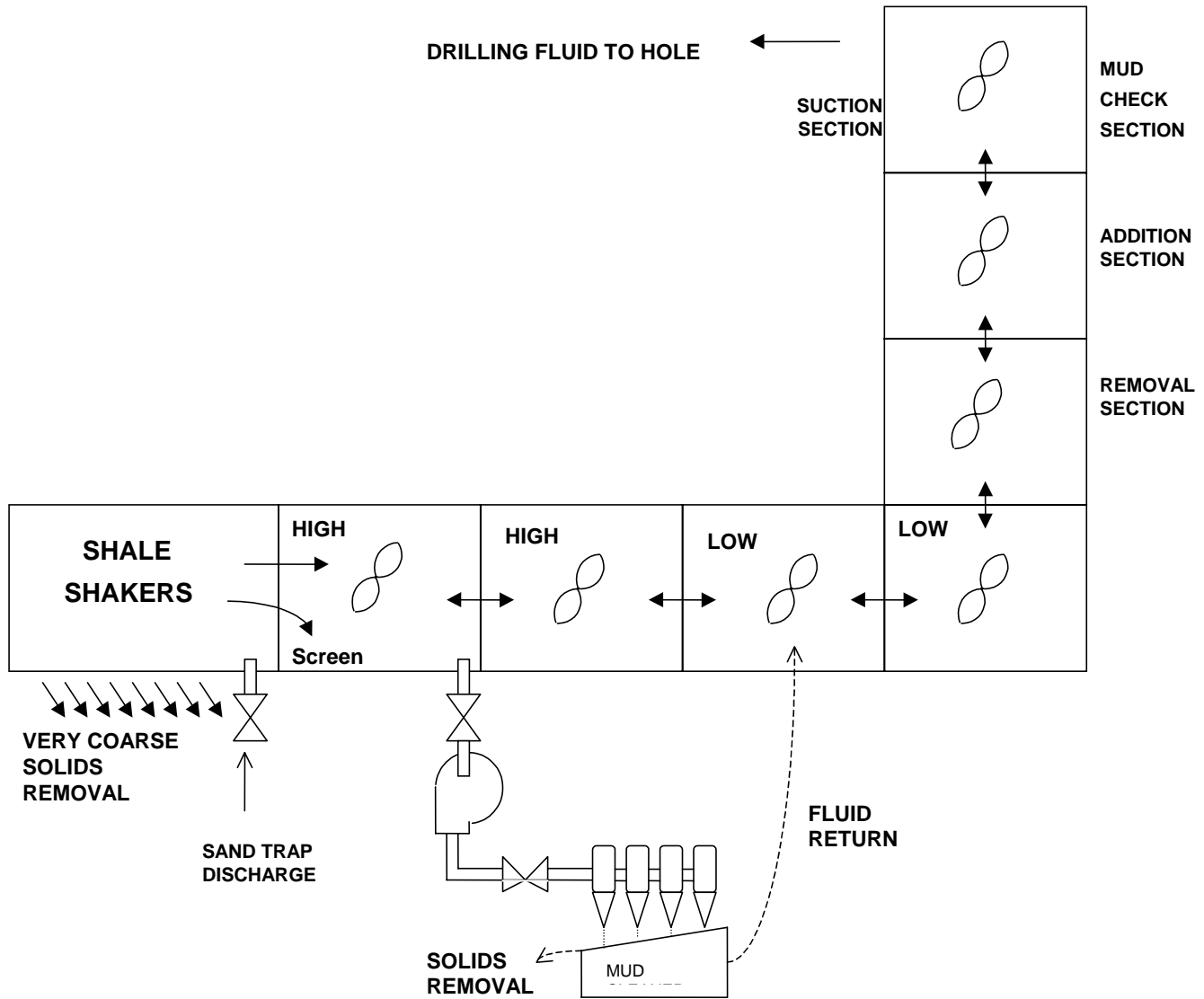

**Drawing: Mechanical Solids Control of Weighted Drilling Mud**

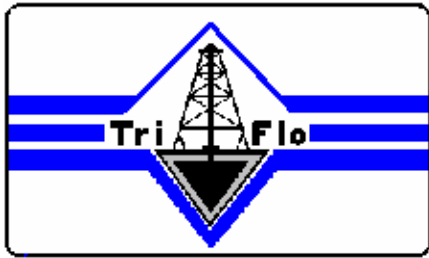

# Tri-Flo Int'l, Inc.

P.O. Box 2626, Conroe, Texas 77305  
 Bus: (936) 856-8551 Fax: (936) 856-5668

## Centrifuge

Removes low gravity solids and Barite smaller than 15 microns.

Returns smaller solids to active mud system.

Operates on small fraction of total mud system.

## Mud Cleaner

Removes drilled solids larger than 74-105 microns before they degrade onto ultra fine solids, which cause viscosity build-up. Small amounts of oversized Barite and some colloidal Barite may be removed with drilled solids.

Returns smaller solids including barite to active system.

Operates on entire circulating volume.

## Fine Screen Shale Shaker

Removes drilled solids larger than 177-260 microns. Small amounts of colloidal barite may be removed with drilled solids.

Returns smaller solids to active mud system.

Operates on entire circulating volume.

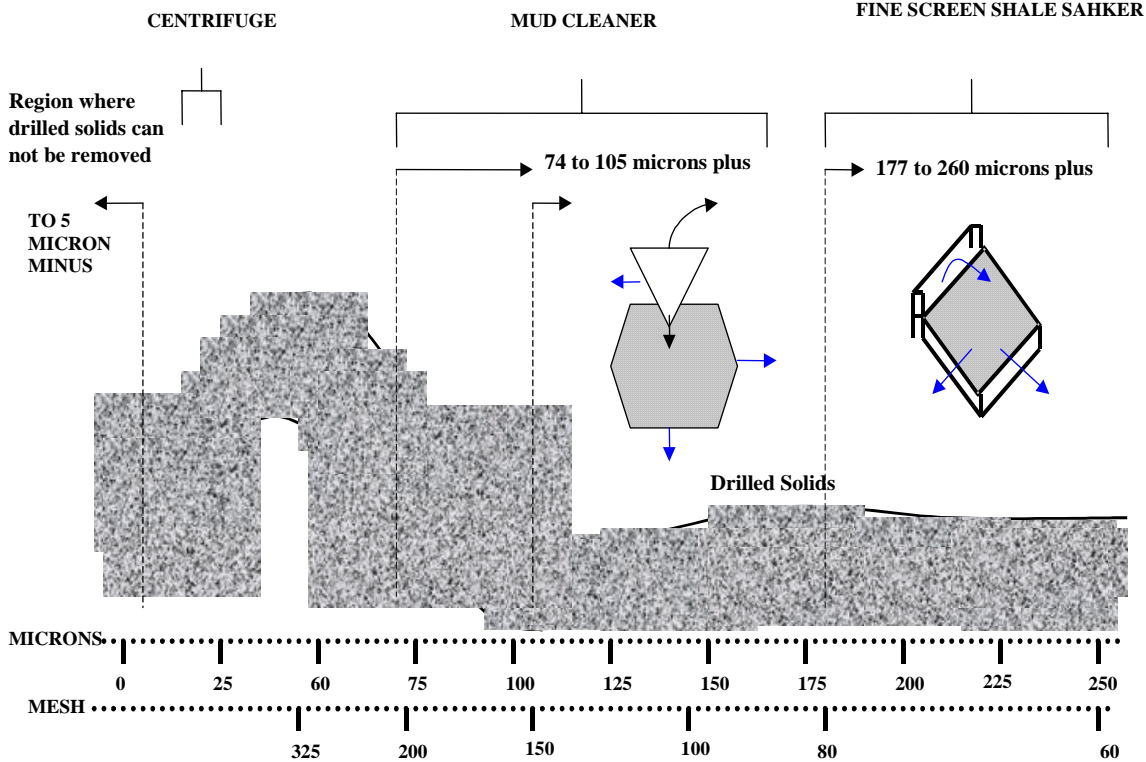

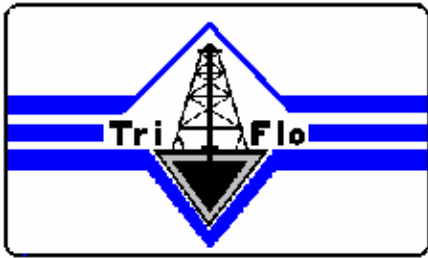

## Tri-Flo Int'l, Inc.

P.O. Box 2626, Conroe, Texas 77305  
 Bus: (936) 856-8551 Fax: (936) 856-5668

### LOW VOLTAGE WIRING

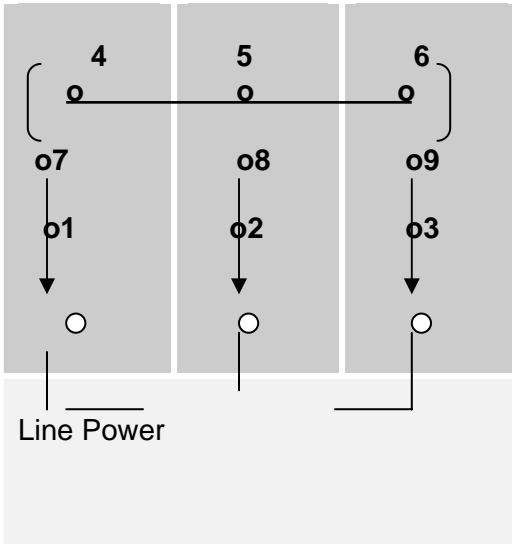

Motor leads 4-5-6 together tape  
 Motor leads 7-1 power lead 1 - tape  
 Motor leads 8-2 power lead 2 - tape  
 Motor leads 9-3 power lead 3 - tape

Note: The low voltage heater is a H29, parte No. 01-00-042 If it is necessary to change from high voltage (460 V.A.C.) to low voltage (230 V.A.C.), the heater must be changed.

### HIGH VOLTAGE WIRING

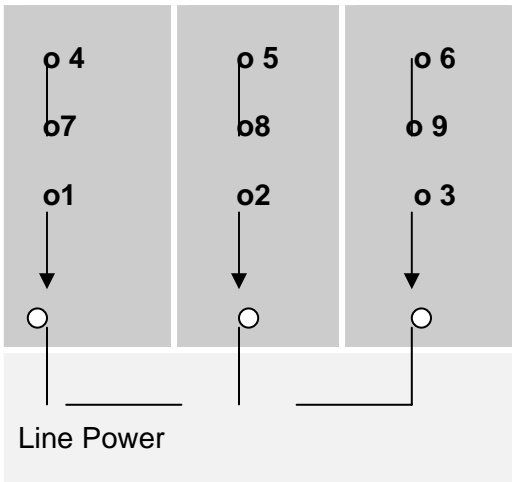

Motor lead 4-7 tape  
 Motor lead 5-8 tape  
 Motor lead 6-9 tape  
 Motor lead 1 – to power lead 1 – tape  
 Motor lead 2 - to power lead 2 – tape  
 Motor lead 3 - to power lead 3 – tape

Note: High Voltage heater is a H23. TRI-FLO Part No. 01-00-055. If it is necessary to change from low voltage (230 V.A.C.) to High voltage (460 V.A.C.), the heater must be changed.

**NOTE:** (If the motor rotates in wrong direction reverse any two of the power leads.)

**NOTE:** IF THE MOTOR JUNCTION BOX IS REWIRED OR CHANGED IT MUST BE PACKED WITH FOAM RUBBER TO PREVENT THE WIRES FROM RUBBING TOGETHER WHEN THE SHAKER IS VIBRATING.

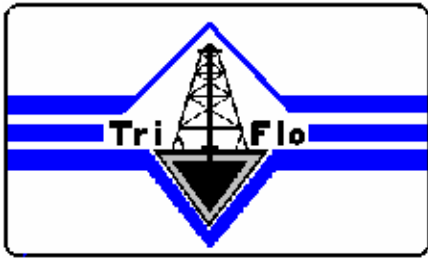

**Tri-Flo Int'l, Inc.**  
 P.O. Box 2626, Conroe, Texas 77305  
 Bus: (936) 856-8551 Fax: (936) 856-5668

**TENSION PLATE AND SCREEN ASSEMBLY**

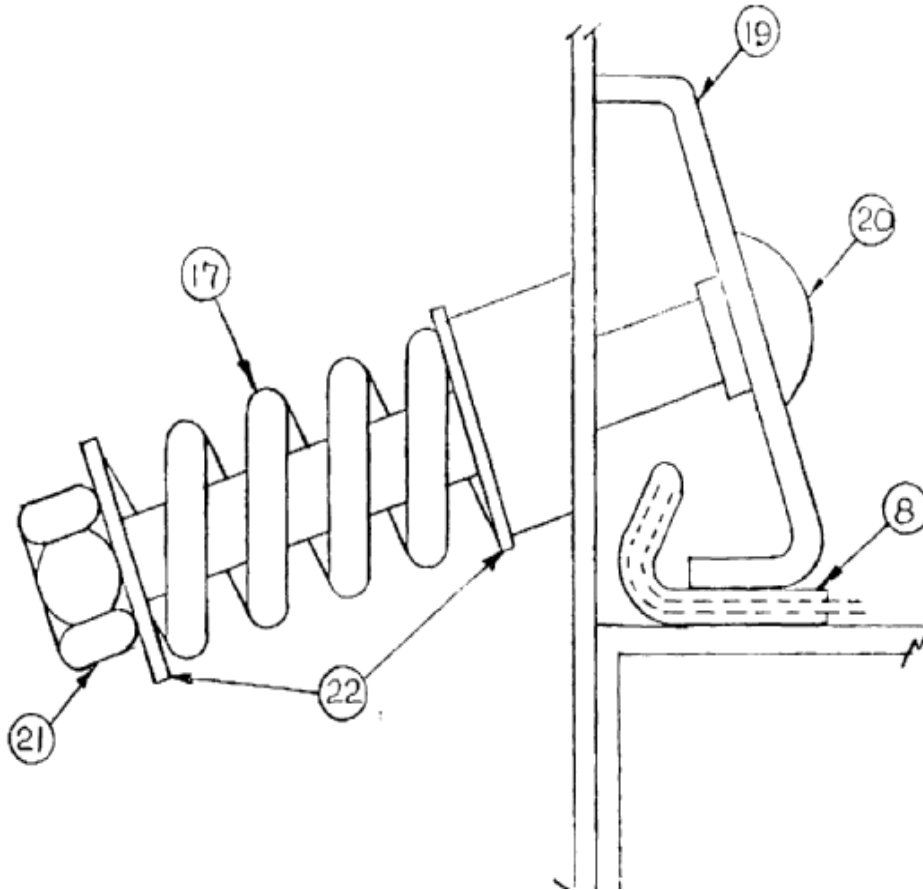

**Part**

Tension Bolt Assembly  
 (includes bolt, nut spring, & 2 washers)  
 Tension Bolt (Item 20)  
 Tension Spring (Item 17)  
 Tension Lock Nut (Item 21)  
 Tension Washer (Item 22)  
 Tension Rail Plate

**Tri-Flo Part No.**

03-00-006  
  
 04-00-107  
 05-00-350  
 04-00-150  
 04-00-177  
 03-00-007

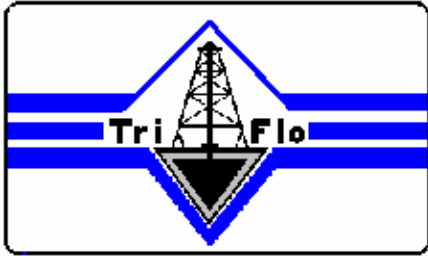

**Tri-Flo Int'l, Inc.**  
 P.O. Box 2626, Conroe, Texas 77305  
 Bus: (936) 856-8551 Fax: (936) 856-5668

**COMMON OILFIELD SHAKER SCREENS**

<b>Mesh</b>	<b>Wire Diameter</b>	<b>Opening Inches</b>	<b>Opening Microns</b>	<b>Open Area</b>
8x8	.028	.097	2464	60.2
10x10	.025	.075	1905	56.3
12x12	.023	.060	1524	51.8
14x14	.020	.051	1295	51.0
16x16	.018	.0445	1130	50.7
18x18	.018	.0376	955	45.8
20x20	.017	.033	838	43.6
8x20	.032/.020	.093/.030	2362/762	45.7
20x30	.015	.035/.0183	889/465	39.5
30x30	.012	.0213	541	40.8
30x40	.010	.0233/.015	592/381	42.5
40x36	.010	.015/.0178	381/452	40.5
40x40	.010	.015	381	36.0
50x40	.0085	.0115/.0165	292/419	38.3
50x50	.009	.011	279	30.3
60x40	.009	.0077/.016	200/406	31.1
60x60	.0075	.0092	234	30.5
70x30	.0075	.007/.026	178/660	40.3
80x80	.0055	.007	178	31.4
100x100	.0045	.0055	140	30.3
120x120	.0037	.0046	117	30.9
150x150	.0026	.0041	104	37.4
160x160	.0025	.0038	97	37.64
200x200	.0021	.0029	74	33.60

**NOTES**